



FHSST Authors

**The Free High School Science Texts:
Textbooks for High School Students
Studying the Sciences
Chemistry
Grades 10 - 12**

**Version 0
November 9, 2008**

Copyright 2007 "Free High School Science Texts"

Permission **is** granted to copy, distribute and/or modify this document under the terms of the GNU Free Documentation License, Version 1.2 or any later version published by the Free Software Foundation; with no Invariant Sections, no Front-Cover Texts, and no Back-Cover Texts. A copy of the license is included in the section entitled "GNU Free Documentation License".



STOP!!!!

Did you notice the **FREEDOMS** we've granted you?

Our copyright license is **different!** It grants freedoms rather than just imposing restrictions like all those other textbooks you probably own or use.

- We know people copy textbooks illegally but we would LOVE it if you copied our's - go ahead copy to your hearts content, **legally!**
- Publishers' revenue is generated by controlling the market, we don't want any money, go ahead, distribute our books far and wide - we DARE you!
- Ever wanted to change your textbook? Of course you have! Go ahead, change ours, make your own version, get your friends together, rip it apart and put it back together the way you like it. That's what we really want!
- Copy, modify, adapt, enhance, share, critique, adore, and contextualise. Do it all, do it with your colleagues, your friends, or alone but get involved! Together we can overcome the challenges our complex and diverse country presents.
- So what is the catch? The only thing you can't do is take this book, make a few changes and then tell others that they can't do the same with your changes. It's share and share-alike and we know you'll agree that is only fair.
- These books were written by volunteers who want to help support education, who want the facts to be freely available for teachers to copy, adapt and re-use. Thousands of hours went into making them and they are a gift to everyone in the education community.

FHSST Core Team

Mark Horner ; Samuel Halliday ; Sarah Blyth ; Rory Adams ; Spencer Wheaton

FHSST Editors

Jaynie Padayachee ; Joanne Boule ; Diana Mulcahy ; Annette Nell ; René Toerien ; Donovan
Whitfield

FHSST Contributors

Rory Adams ; Prashant Arora ; Richard Baxter ; Dr. Sarah Blyth ; Sebastian Bodenstein ;
Graeme Broster ; Richard Case ; Brett Cocks ; Tim Crombie ; Dr. Anne Dabrowski ; Laura
Daniels ; Sean Dobbs ; Fernando Durrell ; Dr. Dan Dwyer ; Frans van Eeden ; Giovanni
Franzoni ; Ingrid von Glehn ; Tamara von Glehn ; Lindsay Glesener ; Dr. Vanessa Godfrey ; Dr.
Johan Gonzalez ; Hemant Gopal ; Umeshree Govender ; Heather Gray ; Lynn Greeff ; Dr. Tom
Gutierrez ; Brooke Haag ; Kate Hadley ; Dr. Sam Halliday ; Asheena Hanuman ; Neil Hart ;
Nicholas Hatcher ; Dr. Mark Horner ; Robert Hovden ; Mfandaidza Hove ; Jennifer Hsieh ;
Clare Johnson ; Luke Jordan ; Tana Joseph ; Dr. Jennifer Klay ; Lara Kruger ; Sihle Kubheka ;
Andrew Kubik ; Dr. Marco van Leeuwen ; Dr. Anton Machacek ; Dr. Komal Maheshwari ;
Kosma von Maltitz ; Nicole Masureik ; John Mathew ; JoEllen McBride ; Nikolai Meures ;
Riana Meyer ; Jenny Miller ; Abdul Mirza ; Asogan Moodaly ; Jothi Moodley ; Nolene Naidu ;
Tyrone Negus ; Thomas O'Donnell ; Dr. Markus Oldenburg ; Dr. Jaynie Padayachee ;
Nicolette Pekeur ; Sirika Pillay ; Jacques Plaut ; Andrea Prinsloo ; Joseph Raimondo ; Sanya
Rajani ; Prof. Sergey Rakityansky ; Alastair Ramlakan ; Razvan Remsing ; Max Richter ; Sean
Riddle ; Evan Robinson ; Dr. Andrew Rose ; Bianca Ruddy ; Katie Russell ; Duncan Scott ;
Helen Seals ; Ian Sherratt ; Roger Sieloff ; Bradley Smith ; Greg Solomon ; Mike Stringer ;
Shen Tian ; Robert Torregrosa ; Jimmy Tseng ; Helen Waugh ; Dr. Dawn Webber ; Michelle
Wen ; Dr. Alexander Wetzler ; Dr. Spencer Wheaton ; Vivian White ; Dr. Gerald Wigger ;
Harry Wiggins ; Wendy Williams ; Julie Wilson ; Andrew Wood ; Emma Wormauld ; Sahal
Yacoob ; Jean Youssef

Contributors and editors have made a sincere effort to produce an accurate and useful resource.
Should you have suggestions, find mistakes or be prepared to donate material for inclusion,
please don't hesitate to contact us. We intend to work with all who are willing to help make
this a continuously evolving resource!

www.fhsst.org

Contents

I	Introduction	1
II	Matter and Materials	3
1	Classification of Matter - Grade 10	5
1.1	Mixtures	5
1.1.1	Heterogeneous mixtures	6
1.1.2	Homogeneous mixtures	6
1.1.3	Separating mixtures	7
1.2	Pure Substances: Elements and Compounds	9
1.2.1	Elements	9
1.2.2	Compounds	9
1.3	Giving names and formulae to substances	10
1.4	Metals, Semi-metals and Non-metals	13
1.4.1	Metals	13
1.4.2	Non-metals	14
1.4.3	Semi-metals	14
1.5	Electrical conductors, semi-conductors and insulators	14
1.6	Thermal Conductors and Insulators	15
1.7	Magnetic and Non-magnetic Materials	17
1.8	Summary	18
2	What are the objects around us made of? - Grade 10	21
2.1	Introduction: The atom as the building block of matter	21
2.2	Molecules	21
2.2.1	Representing molecules	21
2.3	Intramolecular and intermolecular forces	25
2.4	The Kinetic Theory of Matter	26
2.5	The Properties of Matter	28
2.6	Summary	31
3	The Atom - Grade 10	35
3.1	Models of the Atom	35
3.1.1	The Plum Pudding Model	35
3.1.2	Rutherford's model of the atom	36

3.1.3	The Bohr Model	37
3.2	How big is an atom?	38
3.2.1	How heavy is an atom?	38
3.2.2	How big is an atom?	38
3.3	Atomic structure	38
3.3.1	The Electron	39
3.3.2	The Nucleus	39
3.4	Atomic number and atomic mass number	40
3.5	Isotopes	42
3.5.1	What is an isotope?	42
3.5.2	Relative atomic mass	45
3.6	Energy quantisation and electron configuration	46
3.6.1	The energy of electrons	46
3.6.2	Energy quantisation and line emission spectra	47
3.6.3	Electron configuration	47
3.6.4	Core and valence electrons	51
3.6.5	The importance of understanding electron configuration	51
3.7	Ionisation Energy and the Periodic Table	53
3.7.1	Ions	53
3.7.2	Ionisation Energy	55
3.8	The Arrangement of Atoms in the Periodic Table	56
3.8.1	Groups in the periodic table	56
3.8.2	Periods in the periodic table	58
3.9	Summary	59
4	Atomic Combinations - Grade 11	63
4.1	Why do atoms bond?	63
4.2	Energy and bonding	63
4.3	What happens when atoms bond?	65
4.4	Covalent Bonding	65
4.4.1	The nature of the covalent bond	65
4.5	Lewis notation and molecular structure	69
4.6	Electronegativity	72
4.6.1	Non-polar and polar covalent bonds	73
4.6.2	Polar molecules	73
4.7	Ionic Bonding	74
4.7.1	The nature of the ionic bond	74
4.7.2	The crystal lattice structure of ionic compounds	76
4.7.3	Properties of Ionic Compounds	76
4.8	Metallic bonds	76
4.8.1	The nature of the metallic bond	76
4.8.2	The properties of metals	77

4.9	Writing chemical formulae	78
4.9.1	The formulae of covalent compounds	78
4.9.2	The formulae of ionic compounds	80
4.10	The Shape of Molecules	82
4.10.1	Valence Shell Electron Pair Repulsion (VSEPR) theory	82
4.10.2	Determining the shape of a molecule	82
4.11	Oxidation numbers	85
4.12	Summary	88
5	Intermolecular Forces - Grade 11	91
5.1	Types of Intermolecular Forces	91
5.2	Understanding intermolecular forces	94
5.3	Intermolecular forces in liquids	96
5.4	Summary	97
6	Solutions and solubility - Grade 11	101
6.1	Types of solutions	101
6.2	Forces and solutions	102
6.3	Solubility	103
6.4	Summary	106
7	Atomic Nuclei - Grade 11	107
7.1	Nuclear structure and stability	107
7.2	The Discovery of Radiation	107
7.3	Radioactivity and Types of Radiation	108
7.3.1	Alpha (α) particles and alpha decay	109
7.3.2	Beta (β) particles and beta decay	109
7.3.3	Gamma (γ) rays and gamma decay	110
7.4	Sources of radiation	112
7.4.1	Natural background radiation	112
7.4.2	Man-made sources of radiation	113
7.5	The 'half-life' of an element	113
7.6	The Dangers of Radiation	116
7.7	The Uses of Radiation	117
7.8	Nuclear Fission	118
7.8.1	The Atomic bomb - an abuse of nuclear fission	119
7.8.2	Nuclear power - harnessing energy	120
7.9	Nuclear Fusion	120
7.10	Nucleosynthesis	121
7.10.1	Age of Nucleosynthesis ($225 \text{ s} - 10^3 \text{ s}$)	121
7.10.2	Age of Ions ($10^3 \text{ s} - 10^{13} \text{ s}$)	122
7.10.3	Age of Atoms ($10^{13} \text{ s} - 10^{15} \text{ s}$)	122
7.10.4	Age of Stars and Galaxies (the universe today)	122
7.11	Summary	122

8 Thermal Properties and Ideal Gases - Grade 11	125
8.1 A review of the kinetic theory of matter	125
8.2 Boyle's Law: Pressure and volume of an enclosed gas	126
8.3 Charles's Law: Volume and Temperature of an enclosed gas	132
8.4 The relationship between temperature and pressure	136
8.5 The general gas equation	137
8.6 The ideal gas equation	140
8.7 Molar volume of gases	145
8.8 Ideal gases and non-ideal gas behaviour	146
8.9 Summary	147
9 Organic Molecules - Grade 12	151
9.1 What is organic chemistry?	151
9.2 Sources of carbon	151
9.3 Unique properties of carbon	152
9.4 Representing organic compounds	152
9.4.1 Molecular formula	152
9.4.2 Structural formula	153
9.4.3 Condensed structural formula	153
9.5 Isomerism in organic compounds	154
9.6 Functional groups	155
9.7 The Hydrocarbons	155
9.7.1 The Alkanes	158
9.7.2 Naming the alkanes	159
9.7.3 Properties of the alkanes	163
9.7.4 Reactions of the alkanes	163
9.7.5 The alkenes	166
9.7.6 Naming the alkenes	166
9.7.7 The properties of the alkenes	169
9.7.8 Reactions of the alkenes	169
9.7.9 The Alkynes	171
9.7.10 Naming the alkynes	171
9.8 The Alcohols	172
9.8.1 Naming the alcohols	173
9.8.2 Physical and chemical properties of the alcohols	175
9.9 Carboxylic Acids	176
9.9.1 Physical Properties	177
9.9.2 Derivatives of carboxylic acids: The esters	178
9.10 The Amino Group	178
9.11 The Carbonyl Group	178
9.12 Summary	179

10 Organic Macromolecules - Grade 12	185
10.1 Polymers	185
10.2 How do polymers form?	186
10.2.1 Addition polymerisation	186
10.2.2 Condensation polymerisation	188
10.3 The chemical properties of polymers	190
10.4 Types of polymers	191
10.5 Plastics	191
10.5.1 The uses of plastics	192
10.5.2 Thermoplastics and thermosetting plastics	194
10.5.3 Plastics and the environment	195
10.6 Biological Macromolecules	196
10.6.1 Carbohydrates	197
10.6.2 Proteins	199
10.6.3 Nucleic Acids	202
10.7 Summary	204
III Chemical Change	209
11 Physical and Chemical Change - Grade 10	211
11.1 Physical changes in matter	211
11.2 Chemical Changes in Matter	212
11.2.1 Decomposition reactions	213
11.2.2 Synthesis reactions	214
11.3 Energy changes in chemical reactions	217
11.4 Conservation of atoms and mass in reactions	217
11.5 Law of constant composition	219
11.6 Volume relationships in gases	219
11.7 Summary	220
12 Representing Chemical Change - Grade 10	223
12.1 Chemical symbols	223
12.2 Writing chemical formulae	224
12.3 Balancing chemical equations	224
12.3.1 The law of conservation of mass	224
12.3.2 Steps to balance a chemical equation	226
12.4 State symbols and other information	230
12.5 Summary	232
13 Quantitative Aspects of Chemical Change - Grade 11	233
13.1 The Mole	233
13.2 Molar Mass	235
13.3 An equation to calculate moles and mass in chemical reactions	237

13.4 Molecules and compounds	239
13.5 The Composition of Substances	242
13.6 Molar Volumes of Gases	246
13.7 Molar concentrations in liquids	247
13.8 Stoichiometric calculations	249
13.9 Summary	252
14 Energy Changes In Chemical Reactions - Grade 11	255
14.1 What causes the energy changes in chemical reactions?	255
14.2 Exothermic and endothermic reactions	255
14.3 The heat of reaction	257
14.4 Examples of endothermic and exothermic reactions	259
14.5 Spontaneous and non-spontaneous reactions	260
14.6 Activation energy and the activated complex	261
14.7 Summary	264
15 Types of Reactions - Grade 11	267
15.1 Acid-base reactions	267
15.1.1 What are acids and bases?	267
15.1.2 Defining acids and bases	267
15.1.3 Conjugate acid-base pairs	269
15.1.4 Acid-base reactions	270
15.1.5 Acid-carbonate reactions	274
15.2 Redox reactions	276
15.2.1 Oxidation and reduction	277
15.2.2 Redox reactions	278
15.3 Addition, substitution and elimination reactions	280
15.3.1 Addition reactions	280
15.3.2 Elimination reactions	281
15.3.3 Substitution reactions	282
15.4 Summary	283
16 Reaction Rates - Grade 12	287
16.1 Introduction	287
16.2 Factors affecting reaction rates	289
16.3 Reaction rates and collision theory	293
16.4 Measuring Rates of Reaction	295
16.5 Mechanism of reaction and catalysis	297
16.6 Chemical equilibrium	300
16.6.1 Open and closed systems	302
16.6.2 Reversible reactions	302
16.6.3 Chemical equilibrium	303
16.7 The equilibrium constant	304

16.7.1	Calculating the equilibrium constant	305
16.7.2	The meaning of k_c values	306
16.8	Le Chatelier's principle	310
16.8.1	The effect of concentration on equilibrium	310
16.8.2	The effect of temperature on equilibrium	310
16.8.3	The effect of pressure on equilibrium	312
16.9	Industrial applications	315
16.10	Summary	316
17	Electrochemical Reactions - Grade 12	319
17.1	Introduction	319
17.2	The Galvanic Cell	320
17.2.1	Half-cell reactions in the Zn-Cu cell	321
17.2.2	Components of the Zn-Cu cell	322
17.2.3	The Galvanic cell	323
17.2.4	Uses and applications of the galvanic cell	324
17.3	The Electrolytic cell	325
17.3.1	The electrolysis of copper sulphate	326
17.3.2	The electrolysis of water	327
17.3.3	A comparison of galvanic and electrolytic cells	328
17.4	Standard Electrode Potentials	328
17.4.1	The different reactivities of metals	329
17.4.2	Equilibrium reactions in half cells	329
17.4.3	Measuring electrode potential	330
17.4.4	The standard hydrogen electrode	330
17.4.5	Standard electrode potentials	333
17.4.6	Combining half cells	337
17.4.7	Uses of standard electrode potential	338
17.5	Balancing redox reactions	342
17.6	Applications of electrochemistry	347
17.6.1	Electroplating	347
17.6.2	The production of chlorine	348
17.6.3	Extraction of aluminium	349
17.7	Summary	349
IV	Chemical Systems	353
18	The Water Cycle - Grade 10	355
18.1	Introduction	355
18.2	The importance of water	355
18.3	The movement of water through the water cycle	356
18.4	The microscopic structure of water	359

18.4.1	The polar nature of water	359
18.4.2	Hydrogen bonding in water molecules	359
18.5	The unique properties of water	360
18.6	Water conservation	363
18.7	Summary	366
19	Global Cycles: The Nitrogen Cycle - Grade 10	369
19.1	Introduction	369
19.2	Nitrogen fixation	369
19.3	Nitrification	371
19.4	Denitrification	372
19.5	Human Influences on the Nitrogen Cycle	372
19.6	The industrial fixation of nitrogen	373
19.7	Summary	374
20	The Hydrosphere - Grade 10	377
20.1	Introduction	377
20.2	Interactions of the hydrosphere	377
20.3	Exploring the Hydrosphere	378
20.4	The Importance of the Hydrosphere	379
20.5	Ions in aqueous solution	379
20.5.1	Dissociation in water	380
20.5.2	Ions and water hardness	382
20.5.3	The pH scale	382
20.5.4	Acid rain	384
20.6	Electrolytes, ionisation and conductivity	386
20.6.1	Electrolytes	386
20.6.2	Non-electrolytes	387
20.6.3	Factors that affect the conductivity of water	387
20.7	Precipitation reactions	389
20.8	Testing for common anions in solution	391
20.8.1	Test for a chloride	391
20.8.2	Test for a sulphate	391
20.8.3	Test for a carbonate	392
20.8.4	Test for bromides and iodides	392
20.9	Threats to the Hydrosphere	393
20.10	Summary	394
21	The Lithosphere - Grade 11	397
21.1	Introduction	397
21.2	The chemistry of the earth's crust	398
21.3	A brief history of mineral use	399
21.4	Energy resources and their uses	400

21.5 Mining and Mineral Processing: Gold	401
21.5.1 Introduction	401
21.5.2 Mining the Gold	401
21.5.3 Processing the gold ore	401
21.5.4 Characteristics and uses of gold	402
21.5.5 Environmental impacts of gold mining	404
21.6 Mining and mineral processing: Iron	406
21.6.1 Iron mining and iron ore processing	406
21.6.2 Types of iron	407
21.6.3 Iron in South Africa	408
21.7 Mining and mineral processing: Phosphates	409
21.7.1 Mining phosphates	409
21.7.2 Uses of phosphates	409
21.8 Energy resources and their uses: Coal	411
21.8.1 The formation of coal	411
21.8.2 How coal is removed from the ground	411
21.8.3 The uses of coal	412
21.8.4 Coal and the South African economy	412
21.8.5 The environmental impacts of coal mining	413
21.9 Energy resources and their uses: Oil	414
21.9.1 How oil is formed	414
21.9.2 Extracting oil	414
21.9.3 Other oil products	415
21.9.4 The environmental impacts of oil extraction and use	415
21.10 Alternative energy resources	415
21.11 Summary	417
22 The Atmosphere - Grade 11	421
22.1 The composition of the atmosphere	421
22.2 The structure of the atmosphere	422
22.2.1 The troposphere	422
22.2.2 The stratosphere	422
22.2.3 The mesosphere	424
22.2.4 The thermosphere	424
22.3 Greenhouse gases and global warming	426
22.3.1 The heating of the atmosphere	426
22.3.2 The greenhouse gases and global warming	426
22.3.3 The consequences of global warming	429
22.3.4 Taking action to combat global warming	430
22.4 Summary	431

23 The Chemical Industry - Grade 12	435
23.1 Introduction	435
23.2 Sasol	435
23.2.1 Sasol today: Technology and production	436
23.2.2 Sasol and the environment	440
23.3 The Chloralkali Industry	442
23.3.1 The Industrial Production of Chlorine and Sodium Hydroxide	442
23.3.2 Soaps and Detergents	446
23.4 The Fertiliser Industry	450
23.4.1 The value of nutrients	450
23.4.2 The Role of fertilisers	450
23.4.3 The Industrial Production of Fertilisers	451
23.4.4 Fertilisers and the Environment: Eutrophication	454
23.5 Electrochemistry and batteries	456
23.5.1 How batteries work	456
23.5.2 Battery capacity and energy	457
23.5.3 Lead-acid batteries	457
23.5.4 The zinc-carbon dry cell	459
23.5.5 Environmental considerations	460
23.6 Summary	461
A GNU Free Documentation License	467

Chapter 10

Organic Macromolecules - Grade 12

As its name suggests, a macromolecule is a large molecule that forms when lots of smaller molecules are joined together. In this chapter, we will be taking a closer look at the structure and properties of different macromolecules, and at how they form.

10.1 Polymers

Some macromolecules are made up of lots of repeating structural units called **monomers**. To put it more simply, a monomer is like a building block. When lots of similar monomers are joined together by covalent bonds, they form a **polymer**. In an **organic polymer**, the monomers would be joined by the *carbon* atoms of the polymer 'backbone'. A polymer can also be **inorganic**, in which case there may be atoms such as *silicon* in the place of carbon atoms. The key feature that makes a polymer different from other macromolecules, is the repetition of identical or similar monomers in the polymer chain. The examples shown below will help to make these concepts clearer.



Definition: Polymer

Polymer is a term used to describe large molecules consisting of repeating structural units, or monomers, connected by covalent chemical bonds.

1. Polyethene

Chapter 9 looked at the structure of a group of hydrocarbons called the *alkenes*. One example is the molecule **ethene**. The structural formula of ethene is shown in figure 10.1. When lots of ethene molecules bond together, a polymer called **polyethene** is formed. Ethene is the *monomer* which, when joined to other ethene molecules, forms the *polymer polyethene*. Polyethene is a cheap plastic that is used to make plastic bags and bottles.

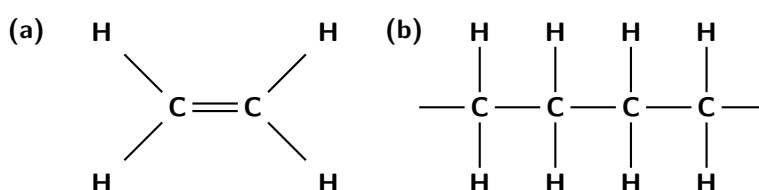

Figure 10.1: (a) Ethene monomer and (b) polyethene polymer

A polymer may be a chain of thousands of monomers, and so it is impossible to draw the entire polymer. Rather, the structure of a polymer can be condensed and represented as shown in figure 10.2. The monomer is enclosed in brackets and the 'n' represents the number of ethene molecules in the polymer, where 'n' is any whole number. What this shows is that the ethene monomer is repeated an indefinite number of times in a molecule of polyethene.

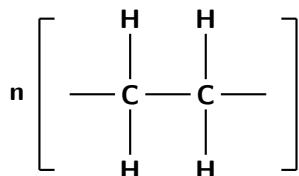

Figure 10.2: A simplified representation of a polyethene molecule

2. Polypropene

Another example of a polymer is *polypropene* (fig 10.3). Polypropene is also a plastic, but is stronger than polyethene and is used to make crates, fibres and ropes. In this polymer, the monomer is the alkene called **propene**.

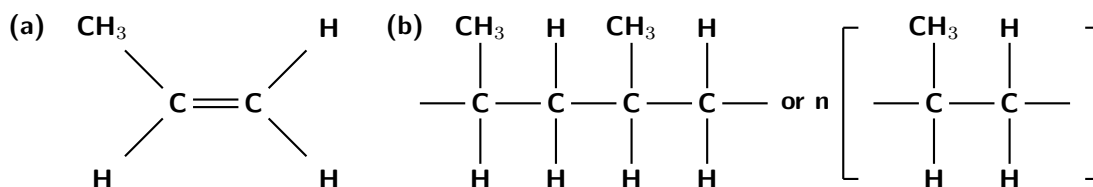

Figure 10.3: (a) Propene monomer and (b) polypropene polymer

10.2 How do polymers form?

Polymers are formed through a process called **polymerisation**, where monomer molecules react together to form a polymer chain. Two types of polymerisation reactions are **addition polymerisation** and **condensation polymerisation**.



Definition: Polymerisation

In chemistry, polymerisation is a process of bonding monomers, or *single units* together through a variety of reaction mechanisms to form longer chains called polymers.

10.2.1 Addition polymerisation

In this type of reaction, monomer molecules are added to a growing polymer chain one at a time. No small molecules are eliminated in the process. An example of this type of reaction is the formation of *polyethene* from *ethene* (fig 10.1). When molecules of ethene are joined to each other, the only thing that changes is that the double bond between the carbon atoms in each ethene monomer is replaced by a single bond so that a new carbon-carbon bond can be formed with the next monomer in the chain. In other words, the monomer is an *unsaturated* compound which, after an addition reaction, becomes a *saturated* compound.



Extension: Initiation, propagation and termination

There are three stages in the process of addition polymerisation. **Initiation** refers to a chemical reaction that triggers off another reaction. In other words, initiation is the starting point of the polymerisation reaction. **Chain propagation** is the part where monomers are continually added to form a longer and longer polymer chain. During chain propagation, it is the reactive end groups of the polymer chain that react in each propagation step, to add a new monomer to the chain. Once a monomer has been added, the reactive part of the polymer is now in this last monomer unit so that propagation will continue. **Termination** refers to a chemical reaction that destroys the reactive part of the polymer chain so that propagation stops.



Worked Example 48: Polymerisation reactions

Question: A polymerisation reaction takes place and the following polymer is formed:

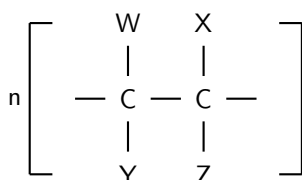

Note: W, X, Y and Z could represent a number of different atoms or combinations of atoms e.g. H, F, Cl or CH₃.

1. Give the structural formula of the monomer of this polymer.
2. To what group of organic compounds does this monomer belong?
3. What type of polymerisation reaction has taken place to join these monomers to form the polymer?

Answer

Step 1 : Look at the structure of the repeating unit in the polymer to determine the monomer.

The monomer is:

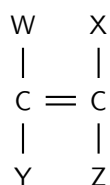

Step 2 : Look at the atoms and bonds in the monomer to determine which group of organic compounds it belongs to.

The monomer has a double bond between two carbon atoms. The monomer must be an alkene.

Step 3 : Determine the type of polymerisation reaction.

In this example, unsaturated monomers combine to form a saturated polymer. No atoms are lost or gained for the bonds between monomers to form. They are simply added to each other. This is an addition reaction.

10.2.2 Condensation polymerisation

In this type of reaction, two monomer molecules form a covalent bond and a small molecule such as water is lost in the bonding process. Nearly all biological reactions are of this type. **Polyester** and **nylon** are examples of polymers that form through condensation polymerisation.

1. Polyester

Polyesters are a group of polymers that contain the **ester** functional group in their main chain. Although there are many forms of polyesters, the term *polyester* usually refers to polyethylene terephthalate (PET). PET is made from ethylene glycol (an alcohol) and terephthalic acid (an acid). In the reaction, a hydrogen atom is lost from the alcohol, and a hydroxyl group is lost from the carboxylic acid. Together these form one water molecule which is lost during condensation reactions. A new bond is formed between an oxygen and a carbon atom. This bond is called an **ester linkage**. The reaction is shown in figure 10.4.

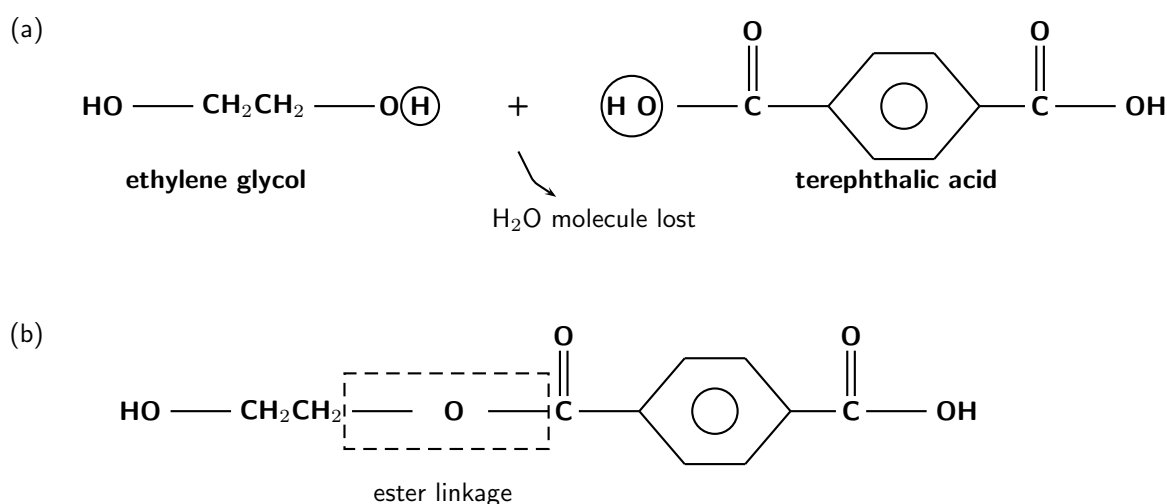
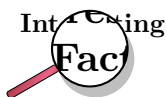

Figure 10.4: An acid and an alcohol monomer react (a) to form a molecule of the polyester 'polyethylene terephthalate' (b).

Polyesters have a number of characteristics which make them very useful. They are resistant to stretching and shrinking, they are easily washed and dry quickly, and they are resistant to mildew. It is for these reasons that polyesters are being used more and more in **textiles**. Polyesters are stretched out into fibres and can then be made into fabric and articles of clothing. In the home, polyesters are used to make clothing, carpets, curtains, sheets, pillows and upholstery.



Polyester is not just a textile. Polyethylene terephthalate is in fact a plastic which can also be used to make plastic drink bottles. Many drink bottles are recycled by being reheated and turned into polyester fibres. This type of recycling helps to reduce disposal problems.

2. Nylon

Nylon was the first polymer to be commercially successful. Nylon replaced silk, and was used to make parachutes during World War 2. Nylon is very strong and resistant, and is used in fishing line, shoes, toothbrush bristles, guitar strings and machine parts to name

just a few. Nylon is formed from the reaction of an amine (1,6-diaminohexane) and an acid monomer (adipic acid) (figure 10.5). The bond that forms between the two monomers is called an **amide linkage**. An amide linkage forms between a nitrogen atom in the amine monomer and the carbonyl group in the carboxylic acid.

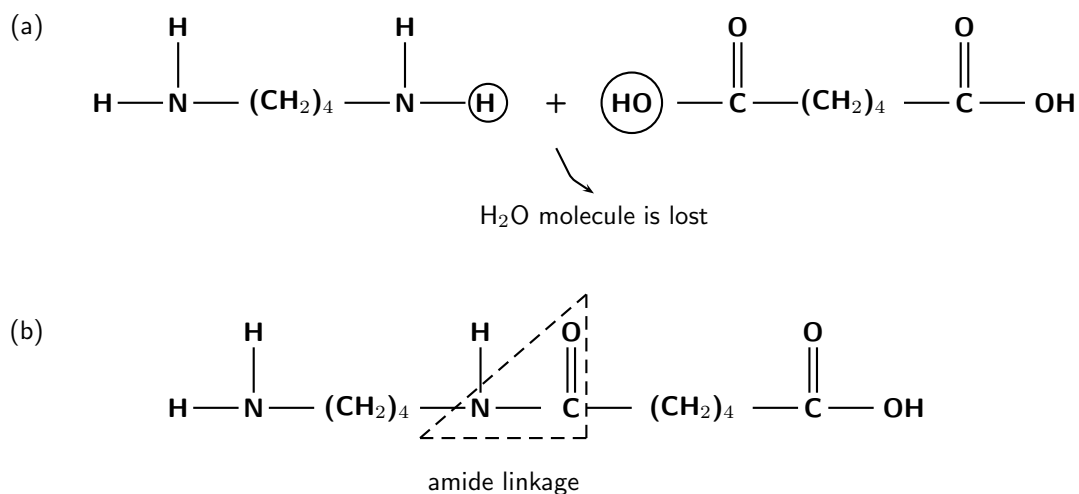
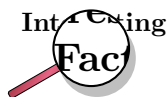

Figure 10.5: An amine and an acid monomer (a) combine to form a section of a nylon polymer (b).



Nylon was first introduced around 1939 and was in high demand to make stockings. However, as World War 2 progressed, nylon was used more and more to make parachutes, and so stockings became more difficult to buy. After the war, when manufacturers were able to shift their focus from parachutes back to stockings, a number of riots took place as women queued to get stockings. In one of the worst disturbances, 40 000 women queued up for 13 000 pairs of stockings, which led to fights breaking out!



Exercise: Polymers

- The following monomer is a reactant in a polymerisation reaction:

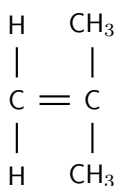

- What is the IUPAC name of this monomer?
- Give the structural formula of the polymer that is formed in this polymerisation reaction.
- Is the reaction an addition or condensation reaction?

2. The polymer below is the product of a polymerisation reaction.

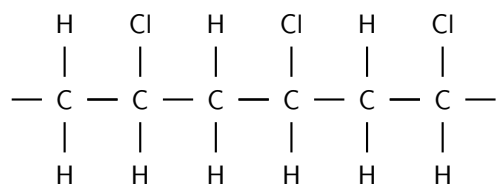

- (a) Give the structural formula of the monomer in this polymer.
 (b) What is the name of the monomer?
 (c) Draw the abbreviated structural formula for the polymer.
 (d) Has this polymer been formed through an addition or condensation polymerisation reaction?
3. A condensation reaction takes place between methanol and methanoic acid.
- (a) Give the structural formula for...
- methanol
 - methanoic acid
 - the product of the reaction
- (b) What is the name of the product? (Hint: The product is an ester)

10.3 The chemical properties of polymers

The attractive forces between polymer chains play a large part in determining a polymer's properties. Because polymer chains are so long, these interchain forces are very important. It is usually the side groups on the polymer that determine what types of intermolecular forces will exist. The greater the strength of the intermolecular forces, the greater will be the tensile strength and melting point of the polymer. Below are some examples:

- **Hydrogen bonds between adjacent chains**

Polymers that contain amide or carbonyl groups can form *hydrogen bonds* between adjacent chains. The positive hydrogen atoms in the N-H groups of one chain are strongly attracted to the oxygen atoms in the C=O groups on another. Polymers that contain *urea* linkages would fall into this category. The structural formula for urea is shown in figure 10.6. Polymers that contain urea linkages have high tensile strength and a high melting point.

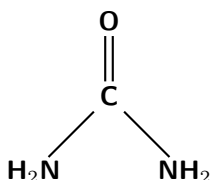

Figure 10.6: The structural formula for urea

- **Dipole-dipole bonds between adjacent chains**

Polyesters have *dipole-dipole bonding* between their polymer chains. Dipole bonding is not as strong as hydrogen bonding, so a polyester's melting point and strength are lower

than those of the polymers where there are hydrogen bonds between the chains. However, the weaker bonds between the chains means that polyesters have greater flexibility. The greater the flexibility of a polymer, the more likely it is to be moulded or stretched into fibres.

- **Weak van der Waal's forces**

Other molecules such as ethene do not have a permanent dipole and so the attractive forces between polyethene chains arise from weak *van der Waals* forces. Polyethene therefore has a lower melting point than many other polymers.

10.4 Types of polymers

There are many different types of polymers. Some are organic, while others are inorganic. Organic polymers can be broadly grouped into either synthetic/semi-synthetic (artificial) or biological (natural) polymers. We are going to take a look at two groups of organic polymers: *plastics*, which are usually synthetic or semi-synthetic and *biological macromolecules* which are natural polymers. Both of these groups of polymers play a very important role in our lives.

10.5 Plastics

In today's world, we can hardly imagine life without plastic. From cellphones to food packaging, fishing line to plumbing pipes, compact discs to electronic equipment, plastics have become a very important part of our daily lives. "Plastics" cover a range of synthetic and semi-synthetic organic polymers. Their name comes from the fact that they are 'malleable', in other words their shape can be changed and moulded.

**Definition: Plastic**

Plastic covers a range of synthetic or semisynthetic organic polymers. Plastics may contain other substances to improve their performance. Their name comes from the fact that many of them are malleable, in other words they have the property of plasticity.

It was only in the nineteenth century that it was discovered that plastics could be made by chemically changing natural polymers. For centuries before this, only natural organic polymers had been used. Examples of natural organic polymers include *waxes* from plants, *cellulose* (a plant polymer used in fibres and ropes) and *natural rubber* from rubber trees. But in many cases, these natural organic polymers didn't have the characteristics that were needed for them to be used in specific ways. Natural rubber for example, is sensitive to temperature and becomes sticky and smelly in hot weather and brittle in cold weather.

In 1834 two inventors, Friedrich Ludersdorf of Germany and Nathaniel Hayward of the US, independently discovered that adding sulfur to raw rubber helped to stop the material from becoming sticky. After this, Charles Goodyear discovered that heating this modified rubber made it more resistant to abrasion, more elastic and much less sensitive to temperature. What these inventors had done was to improve the properties of a natural polymer so that it could be used in new ways. An important use of rubber now is in vehicle tyres, where these properties of rubber are critically important.

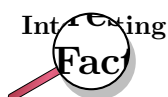

The first true plastic (i.e. one that was not based on any material found in nature) was *Bakelite*, a cheap, strong and durable plastic. Some of these plastics are still used for example in electronic circuit boards, where their properties of insulation and heat resistance are very important.

10.5.1 The uses of plastics

There is such a variety of different plastics available, each having their own specific properties and uses. The following are just a few examples.

- **Polystyrene**

Polystyrene (figure 15.2) is a common plastic that is used in model kits, disposable eating utensils and a variety of other products. In the polystyrene polymer, the monomer is *styrene*, a liquid hydrocarbon that is manufactured from petroleum.

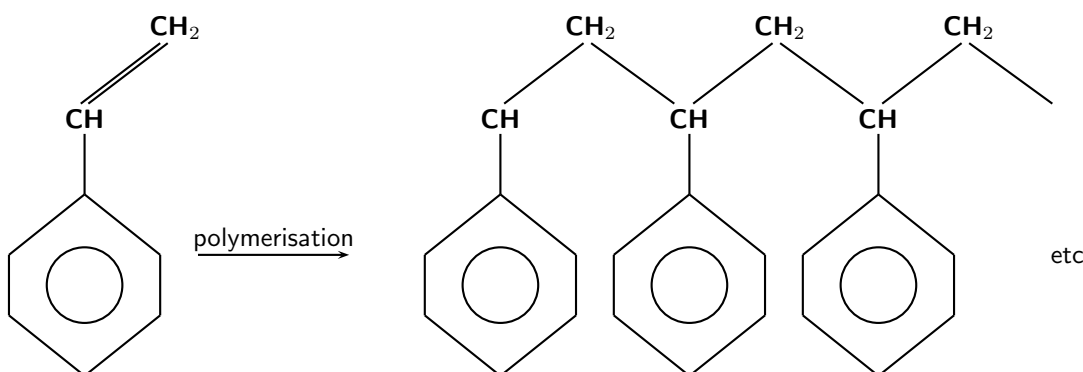

Figure 10.7: The polymerisation of a styrene monomer to form a polystyrene polymer

- **Polyvinylchloride (PVC)**

Polyvinyl chloride (PVC) (figure 10.8) is used in plumbing, gutters, electronic equipment, wires and food packaging. The side chains of PVC contain chlorine atoms, which give it its particular characteristics.

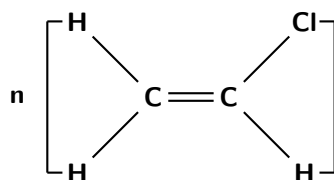
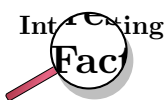

Figure 10.8: Polyvinyl chloride



Many vinyl products have other chemicals added to them to give them particular properties. Some of these chemicals, called additives, can leach out of the vinyl products. In PVC, *plasticizers* are used to make PVC more flexible. Because many baby toys are made from PVC, there is concern that some of these products may leach into the mouths of the babies that are chewing on them. In the USA, most companies have stopped making PVC toys. There are also concerns that some of the plasticizers added to PVC may cause a number of health conditions including cancer.

- **Synthetic rubber**

Another plastic that was critical to the World War 2 effort was *synthetic rubber*, which was produced in a variety of forms. Not only were worldwide natural rubber supplies limited,

but most rubber-producing areas were under Japanese control. Rubber was needed for tyres and parts of war machinery. After the war, synthetic rubber also played an important part in the space race and nuclear arms race.

- **Polyethene/polyethylene (PE)**

Polyethylene (figure 10.1) was discovered in 1933. It is a cheap, flexible and durable plastic and is used to make films and packaging materials, containers and car fittings. One of the most well known polyethylene products is 'Tupperware', the sealable food containers designed by Earl Tupper and promoted through a network of housewives!

- **Polytetrafluoroethylene (PTFE)**

Polytetrafluoroethylene (figure 10.9) is more commonly known as 'Teflon' and is most well known for its use in non-stick frying pans. Teflon is also used to make the breathable fabric Gore-Tex.

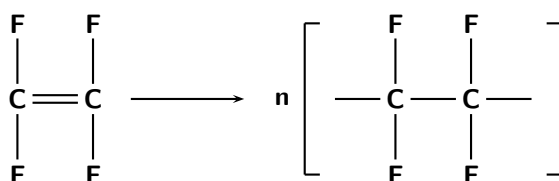

Figure 10.9: A tetra fluoroethylene monomer and polytetrafluoroethylene polymer

Table 10.1 summarises the formulae, properties and uses of some of the most common plastics.

Table 10.1: A summary of the formulae, properties and uses of some common plastics

Name	Formula	Monomer	Properties	Uses
Polyethene (low density)	$-(\text{CH}_2-\text{CH}_2)_n-$	$\text{CH}_2=\text{CH}_2$	soft, waxy solid	film wrap and plastic bags
Polyethene (high density)	$-(\text{CH}_2-\text{CH}_2)_n-$	$\text{CH}_2=\text{CH}_2$	rigid	electrical insulation, bottles and toys
Polypropene	$-(\text{CH}_2-\text{CH}(\text{CH}_3))_n-$	$\text{CH}_2=\text{CHCH}_3$	different grades: some are soft and others hard	carpets and upholstery
Polyvinylchloride (PVC)	$-(\text{CH}_2-\text{CHCl})_n-$	$\text{CH}_2=\text{CHCl}$	strong, rigid	pipes, flooring
Polystyrene	$-(\text{CH}_2-\text{CH}(\text{C}_6\text{H}_5))_n-$	$\text{CH}_2=\text{CHC}_6\text{H}_5$	hard, rigid	toys, packaging
Polytetrafluoroethylene	$-(\text{CF}_2-\text{CF}_2)_n-$	$\text{CF}_2=\text{CF}_2$	resistant, smooth, solid	non-stick surfaces, electrical insulation



Exercise: Plastics

1. It is possible for macromolecules to be composed of more than one type of repeating monomer. The resulting polymer is called a **copolymer**. Varying the monomers that combine to form a polymer, is one way of controlling the properties of the resulting material. Refer to the table below which shows a number of different copolymers of rubber, and answer the questions that follow:

Monomer A	Monomer B	Copolymer	Uses
$\text{H}_2\text{C}=\text{CHCl}$	$\text{H}_2\text{C}=\text{CCl}_2$	Saran	films and fibres
$\text{H}_2\text{C}=\text{CHC}_6\text{H}_5$	$\text{H}_2\text{C}=\text{C}-\text{CH}=\text{CH}_2$	SBR (styrene butadiene rubber)	tyres
$\text{H}_2\text{C}=\text{CHCN}$	$\text{H}_2\text{C}=\text{C}-\text{CH}=\text{CH}_2$	Nitrile rubber	adhesives and hoses
$\text{H}_2\text{C}=\text{C}(\text{CH}_3)_2$	$\text{H}_2\text{C}=\text{C}-\text{CH}=\text{CH}_2$	Butyl rubber	inner tubes
$\text{F}_2\text{C}=\text{CF}(\text{CF}_3)$	$\text{H}_2\text{C}=\text{CHF}$	Viton	gaskets

- Give the structural formula for each of the monomers of nitrile rubber.
 - Give the structural formula of the copolymer viton.
 - In what ways would you expect the properties of SBR to be different from nitrile rubber?
 - Suggest a reason why the properties of these polymers are different.
2. In your home, find as many examples of different types of plastics that you can. Bring them to school and show them to your group. Together, use your examples to complete the following table:

Object	Type of plastic	Properties	Uses

10.5.2 Thermoplastics and thermosetting plastics

A **thermoplastic** is a plastic that can be melted to a liquid when it is heated and freezes to a brittle, glassy state when it is cooled enough. These properties of thermoplastics are mostly due to the fact that the forces between chains are weak. This also means that these plastics can be easily stretched or moulded into any shape. Examples of thermoplastics include nylon, polystyrene, polyethylene, polypropylene and PVC. Thermoplastics are more easily recyclable than some other plastics.

Thermosetting plastics differ from thermoplastics because once they have been formed, they cannot be remelted or remoulded. Examples include bakelite, vulcanised rubber, melanine (used to make furniture), and many glues. Thermosetting plastics are generally stronger than thermoplastics and are better suited to being used in situations where there are high temperatures. They are not able to be recycled. Thermosetting plastics have strong covalent bonds between chains and this makes them very strong.

Activity :: Case Study : Biodegradable plastics

Read the article below and then answer the questions that follow.

Our whole world seems to be wrapped in plastic. Almost every product we buy, most of the food we eat and many of the liquids we drink come encased in plastic. Plastic packaging provides excellent protection for the product, it is cheap to manufacture and seems to last forever. Lasting forever, however, is proving to be a major environmental problem. Another problem is that traditional plastics are manufactured from non-renewable resources - oil, coal and natural gas. In an effort to overcome these problems, researchers and engineers have been trying to develop biodegradable plastics that are made from renewable resources, such as plants.

The term biodegradable means that a substance can be broken down into simpler substances by the activities of living organisms, and therefore is unlikely to remain in the environment. The reason most plastics are not biodegradable is because their long polymer molecules are too large and too tightly bonded together to be broken apart and used by decomposer organisms. However, plastics based on natural plant polymers that come from wheat or corn starch have molecules that can be more easily broken down by microbes.

Starch is a natural polymer. It is a white, granular carbohydrate produced by plants during photosynthesis and it serves as the plant's energy store. Many plants contain large amounts of starch. Starch can be processed directly into a bioplastic but, because it is soluble in water, articles made from starch will swell and deform when exposed to moisture, and this limits its use. This problem can be overcome by changing starch into a different polymer. First, starch is harvested from corn, wheat or potatoes, then microorganisms transform it into lactic acid, a monomer. Finally, the lactic acid is chemically treated to cause the molecules of lactic acid to link up into long chains or polymers, which bond together to form a plastic called polylactide (PLA).

PLA can be used for products such as plant pots and disposable nappies. It has been commercially available in some countries since 1990, and certain blends have proved successful in medical implants, sutures and drug delivery systems because they are able to dissolve away over time. However, because PLA is much more expensive than normal plastics, it has not become as popular as one would have hoped.

Questions

1. In your own words, explain what is meant by a 'biodegradable plastic'.
 2. Using your knowledge of chemical bonding, explain why some polymers are biodegradable and others are not.
 3. Explain why lactic acid is a more useful monomer than starch, when making a biodegradable plastic.
 4. If you were a consumer (shopper), would you choose to buy a biodegradable plastic rather than another? Explain your answer.
 5. What do you think could be done to make biodegradable plastics more popular with consumers?
-

10.5.3 Plastics and the environment

Although plastics have had a huge impact globally, there is also an environmental price that has to be paid for their use. The following are just some of the ways in which plastics can cause damage to the environment.

1. Waste disposal

Plastics are not easily broken down by micro-organisms and therefore most are not easily biodegradable. This leads to waste disposal problems.

2. Air pollution

When plastics burn, they can produce toxic gases such as carbon monoxide, hydrogen cyanide and hydrogen chloride (particularly from PVC and other plastics that contain chlorine and nitrogen).

3. Recycling

It is very difficult to recycle plastics because each type of plastic has different properties and so different recycling methods may be needed for each plastic. However, attempts are being made to find ways of recycling plastics more effectively. Some plastics can be remelted and re-used, while others can be ground up and used as a filler. However,

one of the problems with recycling plastics is that they have to be sorted according to plastic *type*. This process is difficult to do with machinery, and therefore needs a lot of labour. Alternatively, plastics should be re-used. In many countries, including South Africa, shoppers must now pay for plastic bags. This encourages people to collect and re-use the bags they already have.

Activity :: Case Study : Plastic pollution in South Africa

Read the following extract, taken from 'Planet Ark' (September 2003), and then answer the questions that follow.

South Africa launches a programme this week to exterminate its "national flower" - the millions of used plastic bags that litter the landscape.

Beginning on Friday, plastic shopping bags used in the country must be both thicker and more recyclable, a move officials hope will stop people from simply tossing them away. "Government has targeted plastic bags because they are the most visible kind of waste," said Phindile Makwakwa, spokeswoman for the Department of Environmental Affairs and Tourism. "But this is mostly about changing people's mindsets about the environment."

South Africa is awash in plastic pollution. Plastic bags are such a common eyesore that they are dubbed "roadside daisies" and referred to as the national flower. Bill Naude of the Plastics Federation of South Africa said the country used about eight billion plastic bags annually, a figure which could drop by 50 percent if the new law works.

It is difficult sometimes to imagine exactly how much waste is produced in our country every year. Where does all of this go to? You are going to do some simple calculations to try to estimate the volume of plastic packets that is produced in South Africa every year.

1. Take a plastic shopping packet and squash it into a tight ball.
 - (a) Measure the approximate length, breadth and depth of your squashed plastic bag.
 - (b) Calculate the approximate volume that is occupied by the packet.
 - (c) Now calculate the approximate volume of your classroom by measuring its length, breadth and height.
 - (d) Calculate the number of squashed plastic packets that would fit into a classroom of this volume.
 - (e) If South Africa produces an average of 8 billion plastic bags each year, how many classrooms would be filled if all of these bags were thrown away and not re-used?
 2. What has South Africa done to try to reduce the number of plastic bags that are produced?
 3. Do you think this has helped the situation?
 4. What can *you* do to reduce the amount of plastic that you throw away?
-

10.6 Biological Macromolecules

A *biological macromolecule* is one that is found in living organisms. Biological macromolecules include molecules such as carbohydrates, proteins and nucleic acids. Lipids are also biological macromolecules. They are essential for all forms of life to survive.

**Definition: Biological macromolecule**

A biological macromolecule is a polymer that occurs naturally in living organisms. These molecules are essential to the survival of life.

10.6.1 Carbohydrates

Carbohydrates include the sugars and their polymers. One key characteristic of the carbohydrates is that they contain only the elements carbon, hydrogen and oxygen. In the carbohydrate monomers, every carbon except one has a hydroxyl group attached to it, and the remaining carbon atom is double bonded to an oxygen atom to form a carbonyl group. One of the most important monomers in the carbohydrates is **glucose** (figure 10.10). The glucose molecule can exist in an open-chain (acyclic) and ring (cyclic) form.

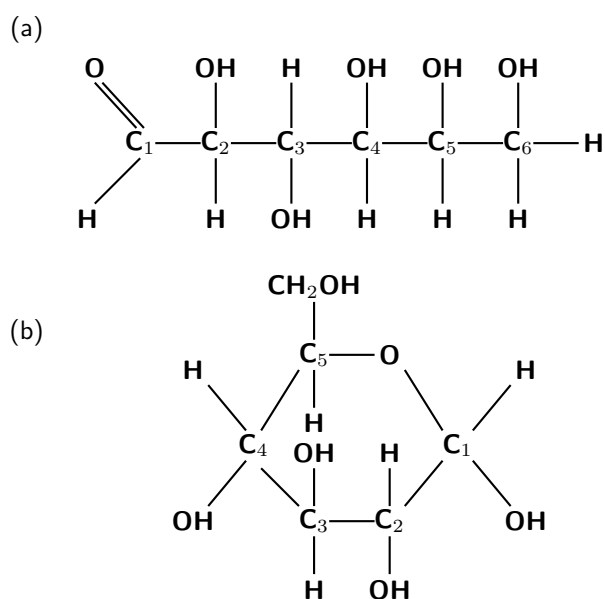

Figure 10.10: The open chain (a) and cyclic (b) structure of a glucose molecule

Glucose is produced during **photosynthesis**, which takes place in plants. During photosynthesis, sunlight (solar energy), water and carbon dioxide are involved in a chemical reaction that produces glucose and oxygen. This glucose is stored in various ways in the plant.

The photosynthesis reaction is as follows:



Glucose is an important source of **energy** for both the plant itself, and also for the other animals and organisms that may feed on it. Glucose plays a critical role in **cellular respiration**, which is a chemical reaction that occurs in the cells of all living organisms. During this reaction, glucose and oxygen react to produce carbon dioxide, water and ATP energy. ATP is a type of energy that can be used by the body's cells so that they can function normally. The purpose of *eating* then, is to obtain glucose which the body can then convert into the ATP energy it needs to be able to survive.

The reaction for cellular respiration is as follows:

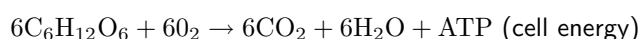

We don't often eat glucose in its simple form. More often, we eat complex carbohydrates that our bodies have to break down into individual glucose molecules before they can be used in cellular respiration. These complex carbohydrates are polymers, which form through condensation polymerisation reactions (figure 10.11). *Starch* and *cellulose* are two examples of carbohydrates that are polymers composed of glucose monomers.

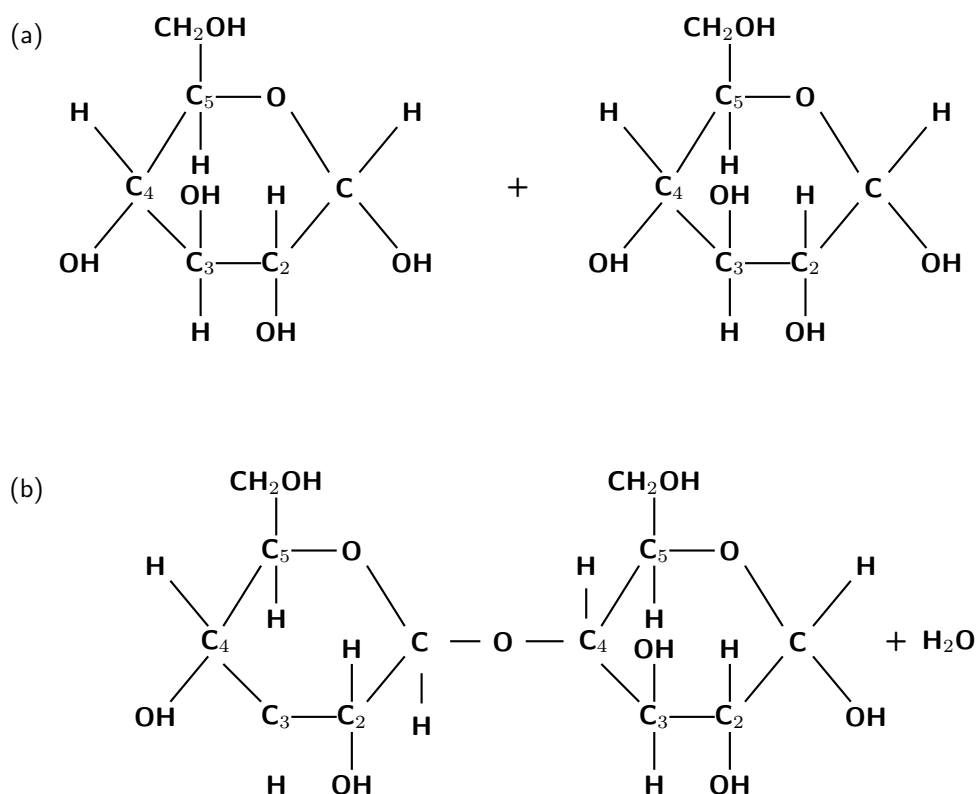

Figure 10.11: Two glucose monomers (a) undergo a condensation reaction to produce a section of a carbohydrate polymer (b). One molecule of water is produced for every two monomers that react.

- **Starch**

Starch is used by plants to store excess glucose, and consists of long chains of glucose monomers. Potatoes are made up almost entirely of starch. This is why potatoes are such a good source of energy. Animals are also able to store glucose, but in this case it is stored as a compound called **glycogen**, rather than as starch.

- **Cellulose**

Cellulose is also made up of chains of glucose molecules, but the bonding between the polymers is slightly different from that in starch. Cellulose is found in the cell walls of plants and is used by plants as a building material.

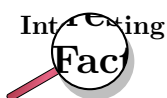

It is very difficult for animals to digest the cellulose in plants that they may have been feeding on. However, fungi and some protozoa are able to break down cellulose. Many animals, including termites and cows, use these organisms to break cellulose down into glucose, which they can then use more easily.

10.6.2 Proteins

Proteins are an incredibly important part of any cell, and they carry out a number of functions such as support, storage and transport within the body. The monomers of proteins are called **amino acids**. An amino acid is an organic molecule that contains a carboxyl and an amino group, as well as a carbon side chain. The carbon side chain varies from one amino acid to the next, and is sometimes simply represented by the letter 'R' in a molecule's structural formula. Figure 10.12 shows some examples of different amino acids.

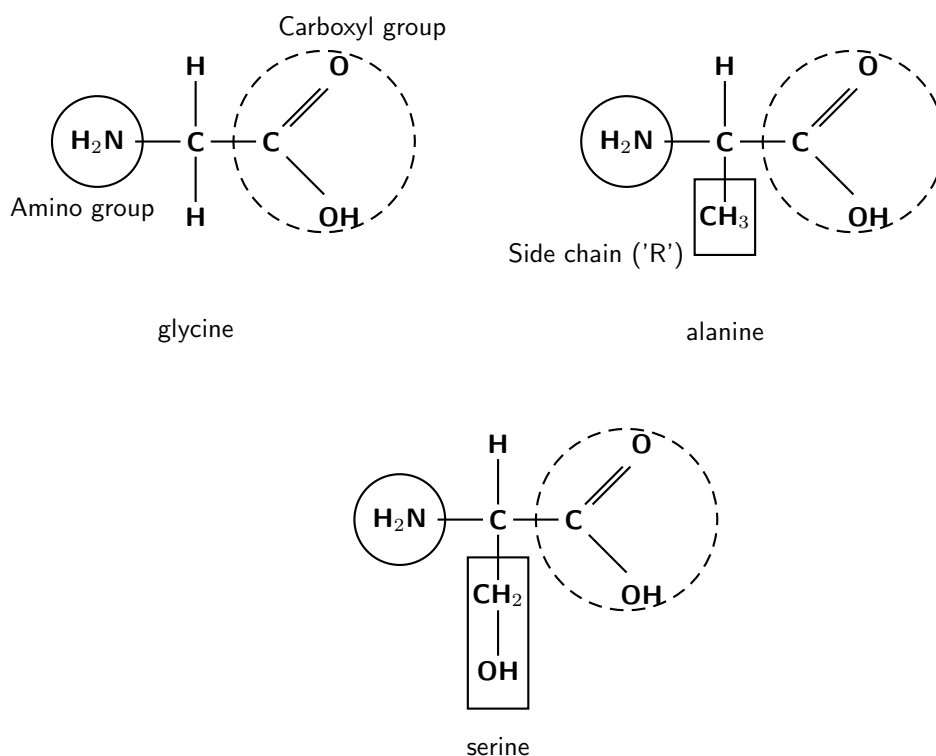

Figure 10.12: Three amino acids: glycine, alanine and serine

Although each of these amino acids has the same basic structure, their side chains ('R' groups) are different. In the amino acid glycine, the side chain consists only of a hydrogen atom, while alanine has a *methyl* side chain. The 'R' group in serine is CH₂ - OH. Amongst other things, the side chains affect whether the amino acid is *hydrophilic* (attracted to water) or *hydrophobic* (repelled by water). If the side chain is *polar*, then the amino acid is hydrophilic, but if the side chain is *non-polar* then the amino acid is hydrophobic. Glycine and alanine both have non-polar side chains, while serine has a polar side chain.



Extension: Charged regions in an amino acid

In an amino acid, the amino group acts as a base because the nitrogen atom has a pair of unpaired electrons which it can use to bond to a hydrogen ion. The amino group therefore attracts the hydrogen ion from the carboxyl group, and ends up having a charge of +1. The carboxyl group from which the hydrogen ion has been taken then has a charge of -1. The amino acid glycine can therefore also be represented as shown in the figure below.

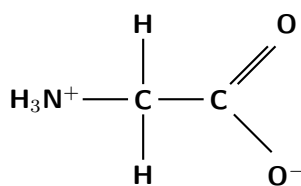

glycine

When two amino acid monomers are close together, they may be joined to each other by **peptide bonds** (figure 10.13) to form a **polypeptide** chain. The reaction is a condensation reaction. Polypeptides can vary in length from a few amino acids to a thousand or more. The polypeptide chains are then joined to each other in different ways to form a **protein**. It is the sequence of the amino acids in the polymer that gives a protein its particular properties.

The sequence of the amino acids in the chain is known as the protein's **primary structure**. As the chain grows in size, it begins to twist, curl and fold upon itself. The different parts of the polypeptide are held together by hydrogen bonds, which form between hydrogen atoms in one part of the chain and oxygen or nitrogen atoms in another part of the chain. This is known as the **secondary structure** of the protein. Sometimes, in this coiled helical structure, bonds may form between the side chains (R groups) of the amino acids. This results in even more irregular contortions of the protein. This is called the **tertiary structure** of the protein.

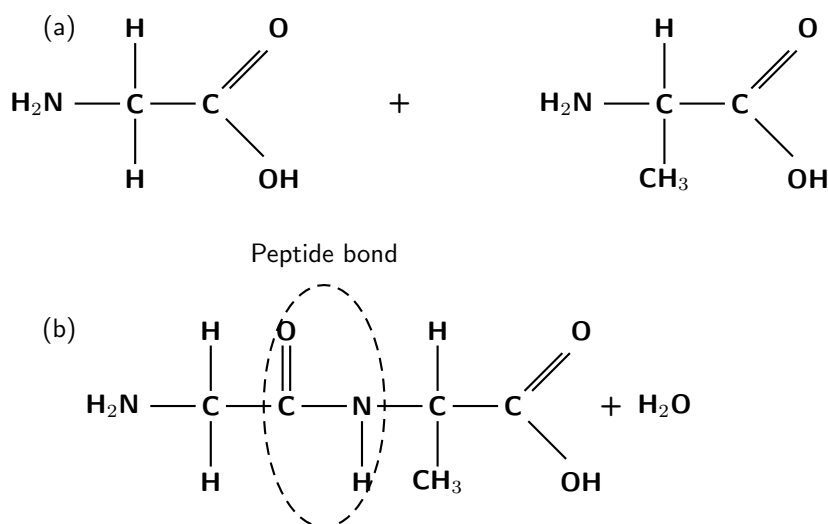
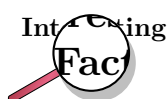

Figure 10.13: Two amino acids (glycine and alanine) combine to form part of a polypeptide chain. The amino acids are joined by a peptide bond between a carbon atom of one amino acid and a nitrogen atom of the other amino acid.



There are twenty different amino acids that exist. All cells, both plant and animal, build their proteins from only twenty amino acids. At first, this seems like a very small number, especially considering the huge number of different

proteins that exist. However, if you consider that most proteins are made up of polypeptide chains that contain at least 100 amino acids, you will start to realise the endless possible combinations of amino acids that are available.

The functions of proteins

Proteins have a number of functions in living organisms.

- *Structural proteins* such as collagen in animal connective tissue and keratin in hair, horns and feather quills, all provide support.
- *Storage proteins* such as albumin in egg white provide a source of energy. Plants store proteins in their seeds to provide energy for the new growing plant.
- *Transport proteins* transport other substances in the body. Haemoglobin in the blood for example, is a protein that contains iron. Haemoglobin has an affinity (attraction) for oxygen and so this is how oxygen is transported around the body in the blood.
- *Hormonal proteins* coordinate the body's activities. Insulin for example, is a hormonal protein that controls the sugar levels in the blood.
- *Enzymes* are chemical catalysts and speed up chemical reactions. Digestive enzymes such as salivary amylase in your saliva, help to break down polymers in food. Enzymes play an important role in all cellular reactions such as respiration, photosynthesis and many others.

Activity :: Research Project : Macromolecules in our daily diet

1. In order to keep our bodies healthy, it is important that we eat a balanced diet with the right amounts of carbohydrates, proteins and fats. Fats are an important source of energy, they provide insulation for the body, and they also provide a protective layer around many vital organs. Our bodies also need certain essential vitamins and minerals. Most food packaging has a label that provides this information.

Choose a number of different food items that you eat. Look at the food label for each, and then complete the following table:

Food	Carbohydrates (%)	Proteins (%)	Fats (%)

- (a) Which food type contains the largest proportion of protein?
 - (b) Which food type contains the largest proportion of carbohydrates?
 - (c) Which of the food types you have listed would you consider to be the 'healthiest'? Give a reason for your answer.
2. In an effort to lose weight, many people choose to *diet*. There are many diets on offer, each of which is based on particular theories about how to lose weight most effectively. Look at the list of diets below:
 - Vegetarian diet
 - Low fat diet
 - Atkin's diet

- Weight Watchers

For each of these diets, answer the following questions:

- What theory of weight loss does each type of diet propose?
 - What are the *benefits* of the diet?
 - What are the potential *problems* with the diet?
-
-



Exercise: Carbohydrates and proteins

- Give the structural formula for each of the following:
 - A polymer chain, consisting of three glucose molecules.
 - A polypeptide chain, consisting of two molecules of alanine and one molecule of serine.
- Write balanced equations to show the polymerisation reactions that produce the polymers described above.
- The following polypeptide is the end product of a polymerisation reaction:

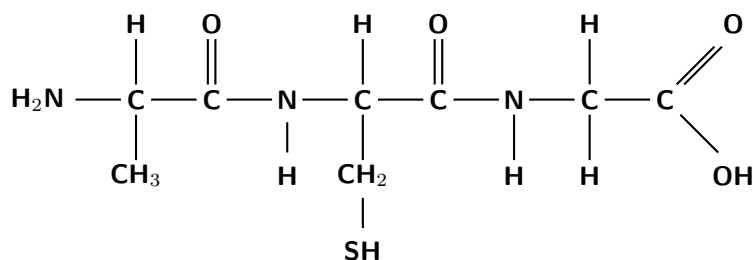

- Give the structural formula of the monomers that make up the polypeptide.
 - On the structural formula of the first monomer, label the amino group and the carboxyl group.
 - What is the chemical formula for the carbon side chain in the second monomer?
 - Name the bond that forms between the monomers of the polypeptide.
-

10.6.3 Nucleic Acids

You will remember that we mentioned earlier that each protein is different because of its unique sequence of amino acids. But what controls how the amino acids arrange themselves to form the specific proteins that are needed by an organism? This task is for the **gene**. A gene contains DNA (deoxyribonucleic acid) which is a polymer that belongs to a class of compounds called the **nucleic acids**. DNA is the genetic material that organisms inherit from their parents. It is DNA that provides the genetic coding that is needed to form the specific proteins that an organism needs. Another nucleic acid is RNA (ribonucleic acid).

The DNA polymer is made up of monomers called **nucleotides**. Each nucleotide has three parts: a sugar, a phosphate and a nitrogenous base. The diagram in figure 10.14 may help you to understand this better.

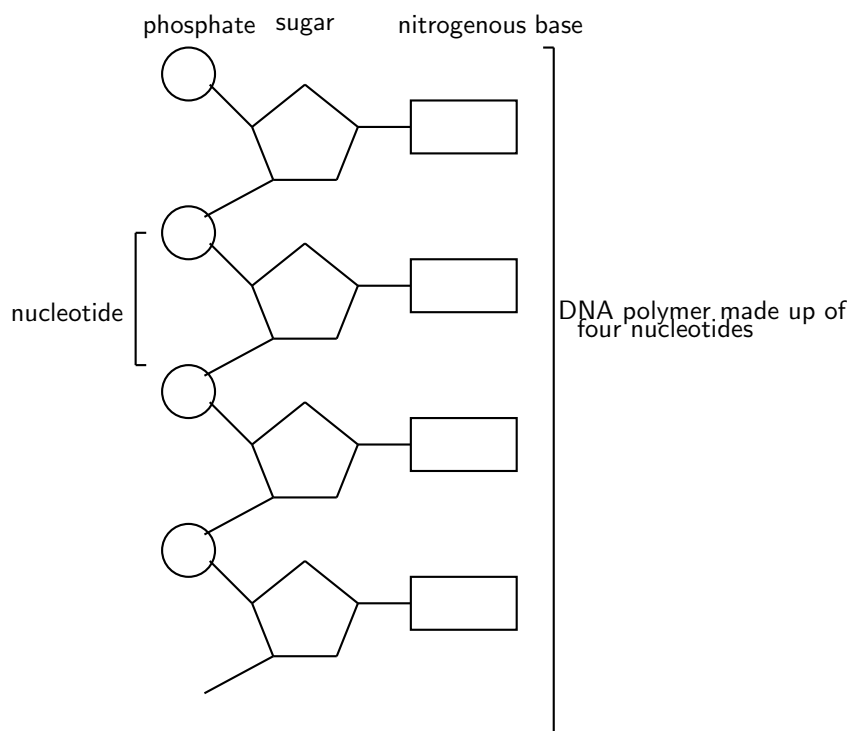
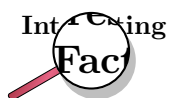

Figure 10.14: Nucleotide monomers make up the DNA polymer

There are five different nitrogenous bases: adenine (A), guanine (G), cytosine (C), thymine (T) and uracil (U). It is the sequence of the nitrogenous bases in a DNA polymer that will determine the genetic code for that organism. Three consecutive nitrogenous bases provide the coding for one amino acid. So, for example, if the nitrogenous bases on three nucleotides are *uracil*, *cytosine* and *uracil* (in that order), one **serine** amino acid will become part of the polypeptide chain. The polypeptide chain is built up in this way until it is long enough (and with the right amino acid sequence) to be a protein. Since proteins control much of what happens in living organisms, it is easy to see how important nucleic acids are as the starting point of this process.



A single defect in even one nucleotide, can be devastating to an organism. One example of this is a disease called **sickle cell anaemia**. Because of one wrong nucleotide in the genetic code, the body produces a protein called **sickle haemoglobin**. Haemoglobin is the protein in red blood cells that helps to transport oxygen around the body. When sickle haemoglobin is produced, the red blood cells change shape. This process damages the red blood cell membrane, and can cause the cells to become stuck in blood vessels. This then means that the red blood cells, which are carrying oxygen, can't get to the tissues where they are needed. This can cause serious organ damage. Individuals who have sickle cell anaemia generally have a lower life expectancy.

Table 10.2 shows some other examples of genetic coding for different amino acids.



Table 10.2: Nitrogenous base sequences and the corresponding amino acid

Nitrogenous base sequence	Amino acid
UUU	Phenylalanine
CUU	Leucine
UCU	Serine
UAU	Tyrosine
UGU	Cysteine
GUU	Valine
GCU	Alanine
GGU	Glycine

- For each of the following, say whether the statement is **true** or **false**. If the statement is *false*, give a reason for your answer.
 - Deoxyribonucleic acid (DNA) is an example of a *polymer* and a nucleotide is an example of a *monomer*.
 - Thymine and uracil are examples of nucleotides.
 - A person's DNA will determine what proteins their body will produce, and therefore what characteristics they will have.
 - An amino acid is a protein monomer.
 - A polypeptide that consists of five amino acids, will also contain five nucleotides.
- For each of the following sequences of nitrogenous bases, write down the amino acid/s that will be part of the polypeptide chain.
 - UUU
 - UCUUUU
 - GGUUAUGUUGGU
- A polypeptide chain consists of three amino acids. The sequence of nitrogenous bases in the nucleotides of the DNA is GCUGGUGCU. Give the structural formula of the polypeptide.

10.7 Summary

- A **polymer** is a macromolecule that is made up of many repeating structural units called **monomers** which are joined by covalent bonds.
- Polymers that contain carbon atoms in the main chain are called **organic polymers**.
- Organic polymers can be divided into **natural organic polymers** (e.g. natural rubber) or **synthetic organic polymers** (e.g. polystyrene).
- The polymer **polyethene** for example, is made up of many ethene monomers that have been joined into a polymer chain.
- Polymers form through a process called **polymerisation**.
- Two examples of polymerisation reactions are **addition** and **condensation** reactions.
- An **addition reaction** occurs when unsaturated monomers (e.g. alkenes) are added to each other one by one. The breaking of a double bond between carbon atoms in the monomer, means that a bond can form with the next monomer. The polymer **polyethene** is formed through an addition reaction.

- In a **condensation reaction**, a molecule of water is released as a product of the reaction. The water molecule is made up of atoms that have been lost from each of the monomers. Polyesters and nylon are polymers that are produced through a condensation reaction.
- The **chemical properties** of polymers (e.g. tensile strength and melting point) are determined by the types of atoms in the polymer, and by the strength of the bonds between adjacent polymer chains. The stronger the bonds, the greater the strength of the polymer, and the higher its melting point.
- One group of synthetic organic polymers, are the **plastics**.
- **Polystyrene** is a plastic that is made up of styrene monomers. Polystyrene is used a lot in packaging.
- **Polyvinyl chloride** (PVC) consists of vinyl chloride monomers. PVC is used to make pipes and flooring.
- **Polyethene**, or **polyethylene**, is made from ethene monomers. Polyethene is used to make film wrapping, plastic bags, electrical insulation and bottles.
- **Polytetrafluoroethylene** is used in non-stick frying pans and electrical insulation.
- A **thermoplastic** can be heated and melted to a liquid. It freezes to a brittle, glassy state when cooled very quickly. Examples of thermoplastics are polyethene and PVC.
- A **thermoset** plastic cannot be melted or re-shaped once formed. Examples of thermoset plastics are vulcanised rubber and melamine.
- It is not easy to **recycle** all plastics, and so they create environmental problems.
- Some of these **environmental problems** include issues of waste disposal, air pollution and recycling.
- A **biological macromolecule** is a polymer that occurs naturally in living organisms.
- Examples of biological macromolecules include **carbohydrates** and **proteins**, both of which are essential for life to survive.
- Carbohydrates include the **sugars** and their polymers, and are an important source of **energy** in living organisms.
- **Glucose** is a carbohydrate monomer. Glucose is the molecule that is needed for **photosynthesis** in plants.
- The glucose monomer is also a building block for carbohydrate polymers such as **starch**, **glycogen** and **cellulose**.
- **Proteins** have a number of important functions. These include their roles in structures, transport, storage, hormonal proteins and enzymes.
- A protein consists of monomers called **amino acids**, which are joined by **peptide bonds**.
- A protein has a **primary**, **secondary** and **tertiary** structure.
- An amino acid is an organic molecule, made up of a **carboxyl** and an **amino** group, as well as a carbon **side chain** of varying lengths.
- It is the **sequence** of amino acids that determines the nature of the protein.
- It is the **DNA** of an organism that determines the order in which amino acids combine to make a protein.
- DNA is a **nucleic acid**. DNA is a polymer, and is made up of monomers called **nucleotides**.
- Each nucleotide consists of a **sugar**, a **phosphate** and a **nitrogenous base**. It is the sequence of the nitrogenous bases that provides the 'code' for the arrangement of the amino acids in a protein.

Exercise: Summary exercise

- Give one word for each of the following descriptions:
 - A chain of monomers joined by covalent bonds.
 - A polymerisation reaction that produces a molecule of water for every two monomers that bond.
 - The bond that forms between an alcohol and a carboxylic acid monomer during a polymerisation reaction.
 - The name given to a protein monomer.
 - A six-carbon sugar monomer.
 - The monomer of DNA, which determines the sequence of amino acids that will make up a protein.
- For each of the following questions, choose the one correct answer from the list provided.
 - A polymer is made up of monomers, each of which has the formula $\text{CH}_2=\text{CHCN}$. The formula of the polymer is:
 - $-(\text{CH}_2=\text{CHCN})_n-$
 - $-(\text{CH}_2-\text{CHCN})_n-$
 - $-(\text{CH}-\text{CHCN})_n-$
 - $-(\text{CH}_3-\text{CHCN})_n-$
 - A polymer has the formula $-\text{[CO}(\text{CH}_2)_4\text{CO-NH}(\text{CH}_2)_6\text{NH}]_n-$. Which of the following statements is **true**?
 - The polymer is the product of an addition reaction.
 - The polymer is a polyester.
 - The polymer contains an amide linkage.
 - The polymer contains an ester linkage.
 - Glucose...
 - is a monomer that is produced during cellular respiration
 - is a sugar polymer
 - is the monomer of starch
 - is a polymer produced during photosynthesis
- The following monomers are involved in a polymerisation reaction:

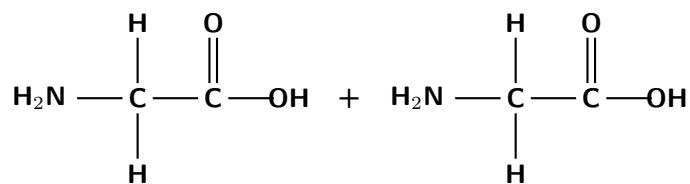

- Give the structural formula of the polymer that is produced.
 - Is the reaction an addition or condensation reaction?
 - To what group of organic compounds do the two monomers belong?
 - What is the name of the monomers?
 - What type of bond forms between the monomers in the final polymer?
- The table below shows the melting point for three plastics. Suggest a reason why the melting point of PVC is *higher* than the melting point for polyethene, but *lower* than that for polyester.

Plastic	Melting point ($^{\circ}\text{C}$)
Polyethene	105 - 115
PVC	212
Polyester	260

5. An amino acid has the formula $\text{H}_2\text{NCH}(\text{CH}_2\text{CH}_2\text{SCH}_3)\text{COOH}$.
- Give the structural formula of this amino acid.
 - What is the chemical formula of the carbon side chain in this molecule?
 - Are there any peptide bonds in this molecule? Give a reason for your answer.
-

you must enclose the copies in covers that carry, clearly and legibly, all these Cover Texts: Front-Cover Texts on the front cover, and Back-Cover Texts on the back cover. Both covers must also clearly and legibly identify you as the publisher of these copies. The front cover must present the full title with all words of the title equally prominent and visible. You may add other material on the covers in addition. Copying with changes limited to the covers, as long as they preserve the title of the Document and satisfy these conditions, can be treated as verbatim copying in other respects.

If the required texts for either cover are too voluminous to fit legibly, you should put the first ones listed (as many as fit reasonably) on the actual cover, and continue the rest onto adjacent pages.

If you publish or distribute Opaque copies of the Document numbering more than 100, you must either include a machine-readable Transparent copy along with each Opaque copy, or state in or with each Opaque copy a computer-network location from which the general network-using public has access to download using public-standard network protocols a complete Transparent copy of the Document, free of added material. If you use the latter option, you must take reasonably prudent steps, when you begin distribution of Opaque copies in quantity, to ensure that this Transparent copy will remain thus accessible at the stated location until at least one year after the last time you distribute an Opaque copy (directly or through your agents or retailers) of that edition to the public.

It is requested, but not required, that you contact the authors of the Document well before redistributing any large number of copies, to give them a chance to provide you with an updated version of the Document.

MODIFICATIONS

You may copy and distribute a Modified Version of the Document under the conditions of sections A and A above, provided that you release the Modified Version under precisely this License, with the Modified Version filling the role of the Document, thus licensing distribution and modification of the Modified Version to whoever possesses a copy of it. In addition, you must do these things in the Modified Version:

1. Use in the Title Page (and on the covers, if any) a title distinct from that of the Document, and from those of previous versions (which should, if there were any, be listed in the History section of the Document). You may use the same title as a previous version if the original publisher of that version gives permission.
2. List on the Title Page, as authors, one or more persons or entities responsible for authorship of the modifications in the Modified Version, together with at least five of the principal authors of the Document (all of its principal authors, if it has fewer than five), unless they release you from this requirement.
3. State on the Title page the name of the publisher of the Modified Version, as the publisher.
4. Preserve all the copyright notices of the Document.
5. Add an appropriate copyright notice for your modifications adjacent to the other copyright notices.
6. Include, immediately after the copyright notices, a license notice giving the public permission to use the Modified Version under the terms of this License, in the form shown in the Addendum below.
7. Preserve in that license notice the full lists of Invariant Sections and required Cover Texts given in the Document's license notice.
8. Include an unaltered copy of this License.
9. Preserve the section Entitled "History", Preserve its Title, and add to it an item stating at least the title, year, new authors, and publisher of the Modified Version as given on the Title Page. If there is no section Entitled "History" in the Document, create one stating the title, year, authors, and publisher of the Document as given on its Title Page, then add an item describing the Modified Version as stated in the previous sentence.

10. Preserve the network location, if any, given in the Document for public access to a Transparent copy of the Document, and likewise the network locations given in the Document for previous versions it was based on. These may be placed in the “History” section. You may omit a network location for a work that was published at least four years before the Document itself, or if the original publisher of the version it refers to gives permission.
11. For any section Entitled “Acknowledgements” or “Dedications”, Preserve the Title of the section, and preserve in the section all the substance and tone of each of the contributor acknowledgements and/or dedications given therein.
12. Preserve all the Invariant Sections of the Document, unaltered in their text and in their titles. Section numbers or the equivalent are not considered part of the section titles.
13. Delete any section Entitled “Endorsements”. Such a section may not be included in the Modified Version.
14. Do not re-title any existing section to be Entitled “Endorsements” or to conflict in title with any Invariant Section.
15. Preserve any Warranty Disclaimers.

If the Modified Version includes new front-matter sections or appendices that qualify as Secondary Sections and contain no material copied from the Document, you may at your option designate some or all of these sections as invariant. To do this, add their titles to the list of Invariant Sections in the Modified Version’s license notice. These titles must be distinct from any other section titles.

You may add a section Entitled “Endorsements”, provided it contains nothing but endorsements of your Modified Version by various parties—for example, statements of peer review or that the text has been approved by an organisation as the authoritative definition of a standard.

You may add a passage of up to five words as a Front-Cover Text, and a passage of up to 25 words as a Back-Cover Text, to the end of the list of Cover Texts in the Modified Version. Only one passage of Front-Cover Text and one of Back-Cover Text may be added by (or through arrangements made by) any one entity. If the Document already includes a cover text for the same cover, previously added by you or by arrangement made by the same entity you are acting on behalf of, you may not add another; but you may replace the old one, on explicit permission from the previous publisher that added the old one.

The author(s) and publisher(s) of the Document do not by this License give permission to use their names for publicity for or to assert or imply endorsement of any Modified Version.

COMBINING DOCUMENTS

You may combine the Document with other documents released under this License, under the terms defined in section A above for modified versions, provided that you include in the combination all of the Invariant Sections of all of the original documents, unmodified, and list them all as Invariant Sections of your combined work in its license notice, and that you preserve all their Warranty Disclaimers.

The combined work need only contain one copy of this License, and multiple identical Invariant Sections may be replaced with a single copy. If there are multiple Invariant Sections with the same name but different contents, make the title of each such section unique by adding at the end of it, in parentheses, the name of the original author or publisher of that section if known, or else a unique number. Make the same adjustment to the section titles in the list of Invariant Sections in the license notice of the combined work.

In the combination, you must combine any sections Entitled “History” in the various original documents, forming one section Entitled “History”; likewise combine any sections Entitled “Acknowledgements”, and any sections Entitled “Dedications”. You must delete all sections Entitled “Endorsements”.

COLLECTIONS OF DOCUMENTS

You may make a collection consisting of the Document and other documents released under this License, and replace the individual copies of this License in the various documents with a single copy that is included in the collection, provided that you follow the rules of this License for verbatim copying of each of the documents in all other respects.

You may extract a single document from such a collection, and distribute it individually under this License, provided you insert a copy of this License into the extracted document, and follow this License in all other respects regarding verbatim copying of that document.

AGGREGATION WITH INDEPENDENT WORKS

A compilation of the Document or its derivatives with other separate and independent documents or works, in or on a volume of a storage or distribution medium, is called an “aggregate” if the copyright resulting from the compilation is not used to limit the legal rights of the compilation’s users beyond what the individual works permit. When the Document is included in an aggregate, this License does not apply to the other works in the aggregate which are not themselves derivative works of the Document.

If the Cover Text requirement of section A is applicable to these copies of the Document, then if the Document is less than one half of the entire aggregate, the Document’s Cover Texts may be placed on covers that bracket the Document within the aggregate, or the electronic equivalent of covers if the Document is in electronic form. Otherwise they must appear on printed covers that bracket the whole aggregate.

TRANSLATION

Translation is considered a kind of modification, so you may distribute translations of the Document under the terms of section A. Replacing Invariant Sections with translations requires special permission from their copyright holders, but you may include translations of some or all Invariant Sections in addition to the original versions of these Invariant Sections. You may include a translation of this License, and all the license notices in the Document, and any Warranty Disclaimers, provided that you also include the original English version of this License and the original versions of those notices and disclaimers. In case of a disagreement between the translation and the original version of this License or a notice or disclaimer, the original version will prevail.

If a section in the Document is Entitled “Acknowledgements”, “Dedications”, or “History”, the requirement (section A) to Preserve its Title (section A) will typically require changing the actual title.

TERMINATION

You may not copy, modify, sub-license, or distribute the Document except as expressly provided for under this License. Any other attempt to copy, modify, sub-license or distribute the Document is void, and will automatically terminate your rights under this License. However, parties who have received copies, or rights, from you under this License will not have their licenses terminated so long as such parties remain in full compliance.

FUTURE REVISIONS OF THIS LICENSE

The Free Software Foundation may publish new, revised versions of the GNU Free Documentation License from time to time. Such new versions will be similar in spirit to the present version, but may differ in detail to address new problems or concerns. See <http://www.gnu.org/copyleft/>.

Each version of the License is given a distinguishing version number. If the Document specifies that a particular numbered version of this License “or any later version” applies to it, you have the option of following the terms and conditions either of that specified version or of any later version that has been published (not as a draft) by the Free Software Foundation. If the Document does not specify a version number of this License, you may choose any version ever published (not as a draft) by the Free Software Foundation.

ADDENDUM: How to use this License for your documents

To use this License in a document you have written, include a copy of the License in the document and put the following copyright and license notices just after the title page:

Copyright © YEAR YOUR NAME. Permission is granted to copy, distribute and/or modify this document under the terms of the GNU Free Documentation License, Version 1.2 or any later version published by the Free Software Foundation; with no Invariant Sections, no Front-Cover Texts, and no Back-Cover Texts. A copy of the license is included in the section entitled “GNU Free Documentation License”.

If you have Invariant Sections, Front-Cover Texts and Back-Cover Texts, replace the “with...Texts.” line with this:

with the Invariant Sections being LIST THEIR TITLES, with the Front-Cover Texts being LIST, and with the Back-Cover Texts being LIST.

If you have Invariant Sections without Cover Texts, or some other combination of the three, merge those two alternatives to suit the situation.

If your document contains nontrivial examples of program code, we recommend releasing these examples in parallel under your choice of free software license, such as the GNU General Public License, to permit their use in free software.